



**ALIENWARE®**



# ACIENWARE M14x MOBILE MANUAL



## Notes, Cautions, and Warnings



**NOTE:** A NOTE indicates important information that helps you make better use of your computer.



**CAUTION:** A CAUTION indicates either potential damage to hardware or loss of data and tells you how to avoid the problem.



**WARNING:** A WARNING indicates a potential for property damage, personal injury, or death.

This item incorporates copy protection technology that is protected by U.S. patents and other intellectual property rights of Rovi Corporation. Reverse engineering and disassembly are prohibited.

**The contents herein are subject to change without notice.**

© 2010–2013 Dell Inc. All rights reserved.

Reproduction of these materials in any manner whatsoever without the prior written permission of Dell Inc. is strictly prohibited.

Trademarks used in this manual: Alienware®, AlienFX®, and the AlienHead logo are trademarks or registered trademarks of Alienware Corporation; Dell™ is a trademark of Dell Inc.; Microsoft®, Windows®, and the Windows start button logo  are either trademarks or registered trademarks of Microsoft Corporation in the United States and/or other countries; Intel®, Centrino®, and SpeedStep® are registered trademarks and Core™ is a trademark of Intel Corporation in the U.S. and other countries; Blu-ray Disc™ is a trademark of the Blu-ray Disc Association; Bluetooth® is a registered trademark owned by Bluetooth SIG, Inc.

Other trademarks and trade names may be used in this manual to refer to either the entities claiming the marks and names or their products. Dell Inc. disclaims any proprietary interest in trademarks and trade names other than its own.

**Regulatory model: P18G      Regulatory type: P18G001**

**Rev. A01      April 2013**

# CONTENTS

<b>CHAPTER 1: SETTING UP YOUR LAPTOP</b> .....	<b>9</b>
Before Setting Up Your Laptop .....	10
Connect the AC Adapter .....	12
Press the Power Button .....	13
Connect the Network Cable (Optional) .....	14
Set Up Microsoft Windows .....	15
Set Up Wireless Display (Optional) .....	16
Connect to the Internet (Optional) .....	19
<b>CHAPTER 2: GETTING TO KNOW YOUR LAPTOP</b> .....	<b>23</b>
Left View Features .....	24
Right View Features .....	28
Back View Features .....	29
Display Features .....	30
Computer Base and Keyboard Features .....	32
Power Button .....	34
Function Keys .....	36

## CONTENTS

<b>CHAPTER 3: USING YOUR LAPTOP</b> .....	<b>39</b>
Alienware Command Center .....	40
Connecting External Displays .....	40
Using the Wireless Control .....	44
Battery Pack .....	45
Power Management .....	46
nVidia Optimus Technology .....	48
Free Fall Sensor .....	50
FastAccess Facial Recognition (Optional) .....	50
Configuring the BIOS .....	51
<b>CHAPTER 4: INSTALLING AND REPLACING COMPONENTS</b> .....	<b>65</b>
Before You Begin .....	66
Replacing the Battery Pack .....	70
Upgrading or Replacing Memory .....	74
<b>CHAPTER 5: TROUBLESHOOTING</b> .....	<b>79</b>
Basic Hints and Tips .....	80
Backup and General Maintenance .....	81
Software Diagnostic Tools .....	83
Answers to Common Problems .....	85

<b>CHAPTER 6: SYSTEM RECOVERY</b> .....	<b>93</b>
AlienRespawn .....	94
My Dell Downloads .....	98
<b>CHAPTER 7: SPECIFICATIONS</b> .....	<b>99</b>
<b>APPENDIX</b> .....	<b>113</b>
GENERAL AND ELECTRICAL SAFETY PRECAUTIONS .....	114
Contacting Alienware .....	117





Dear Valued Alienware Customer,

Welcome to the Alienware family. We are thrilled to include you among the growing number of savvy high-performance computer users.

The Alienware technicians who have crafted your machine have made certain that your high-performance system is properly optimized and performs to its fullest potential. We build machines with one single unwavering purpose: Build It As If It Were Your Own. The technicians will not rest until your new machine meets or exceeds our very demanding criteria!

We have tested your machine extensively in order to ensure that you enjoy the highest levels of performance. In addition to a standard burn-in period, your system has been evaluated using real-world tools such as synthetic performance benchmarks.

We invite you to share your experience with your new high-performance computer with us, so please do not hesitate to either e-mail or call Alienware with any questions or concerns. The entire staff shares your enthusiasm for new technology and we hope that you enjoy using your new computer as much as Alienware enjoyed building it for you.

Sincerely,

Alienware Staff



አዲስ አበባ ዩኒቨርሲቲ ፊት ለፊት ፎካል

# CHAPTER 1: SETTING UP YOUR LAPTOP



# Before Setting Up Your Laptop

### **Congratulations on the purchase of your Alienware M14x!**

Read all safety and setup instructions before connecting your new laptop. Begin by carefully opening the box and removing all components that were shipped to you.

Before setting up your laptop or components, see the included invoice to verify that all items ordered are present and be sure to inspect all items for any physical damage that may have occurred during shipment. Report any missing components or damaged items to customer service within 5 days of receiving the shipment. Anything reported missing or damaged after the first 5 days of receiving a shipment will not be honored. Some of the most common items to check for include:

- Laptop and AC adapter with power cable
- Microsoft CD-key located at the bottom of the laptop
- Monitor with power cable and video cable (if ordered)
- Keyboard (if ordered)
- Mouse (if ordered)
- Multimedia speakers and sub-woofer (if ordered)
- Joystick controllers (if ordered)

You may also need a small flathead and/or a Phillips head screwdriver for connecting peripheral cables to the laptop.

## Product Documentation and Media

The documentation that ships with your Alienware laptop is designed to provide answers to many of the questions that may arise as you explore your new laptop's capabilities. You may see the documentation for technical information or general use as needed to answer questions in the future, or aid you in finding answers and solutions. The media included with your laptop is referenced in some sections of the documentation and may be needed to complete certain tasks. As always, our technical support staff is available to assist you.

## Placing Your Laptop

 **WARNING: Do not place the laptop near or over a radiator or heating vent. If your laptop is placed in a cabinet, ensure that adequate ventilation is provided. Do not place the laptop in a humid location or in any area where the laptop may be exposed to rain or water. Be careful not to spill liquid of any kind on or into the laptop.**

When placing your laptop, ensure that:

- It is placed on a surface that is both level and stable.
- The power and other cable connectors are not jammed between the laptop and a wall – or any other object.
- Nothing obstructs airflow in front of, behind, or below the laptop.
- The laptop has enough room so that optical drives and other external storage drives can be easily accessed.

## Connect the AC Adapter

**⚠ WARNING:** The AC adapter works with electrical outlets worldwide. However, power connectors and power strips vary among countries. Using an incompatible cable or improperly connecting the cable to a power strip or electrical outlet may cause fire or equipment damage.

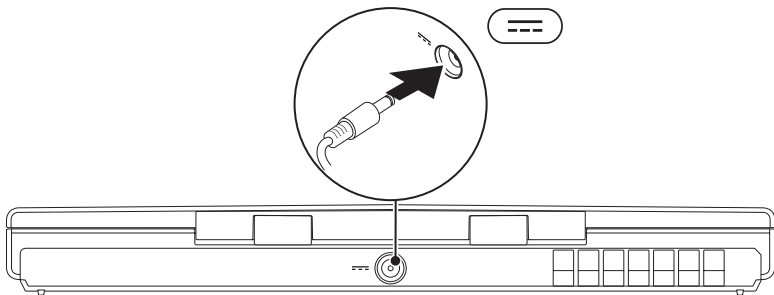

## Press the Power Button

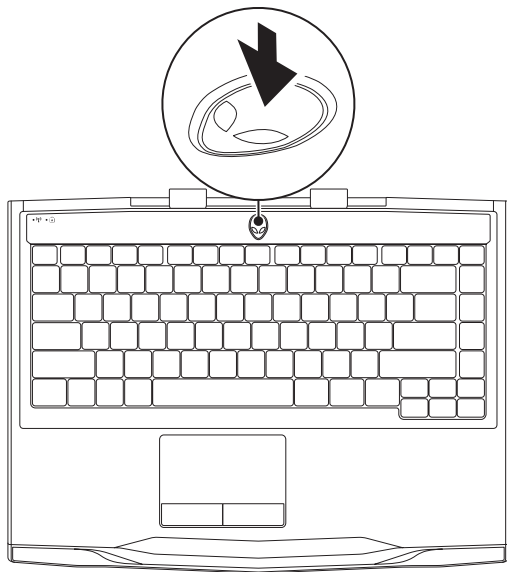

## Connect the Network Cable (Optional)

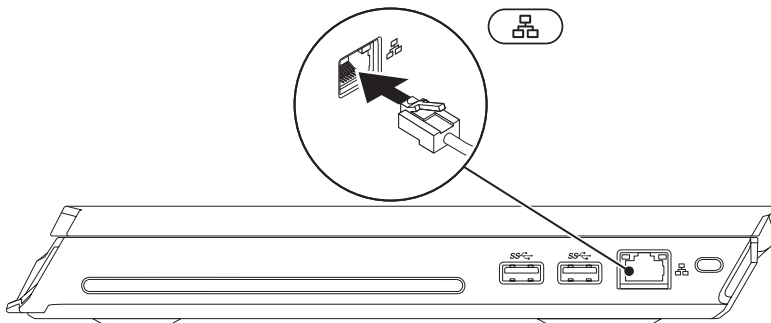





## Set Up Microsoft Windows

Your computer is preconfigured with the Microsoft Windows operating system. To set up Windows for the first time, follow the instructions on the screen. These steps are mandatory and may take some time to complete. The Windows setup screens will take you through several procedures including accepting license agreements, setting preferences, and setting up an Internet connection.

 **CAUTION:** Do not interrupt the operating system's setup process. Doing so may render your computer unusable and you will need to reinstall the operating system.

 **NOTE:** For optimal performance of your computer, it is recommended that you download and install the latest BIOS and drivers for your computer available at [support.dell.com](http://support.dell.com).

 **NOTE:** For more information on the operating system and features, see [support.dell.com/MyNewDell](http://support.dell.com/MyNewDell).

 **NOTE:** It is recommended that you create a full system backup as soon as you set up Microsoft Windows.

# Set Up Wireless Display (Optional)

You can set up wireless display using the following optional wireless display technologies:

- Intel Wireless Display — Designed for watching DVDs and streaming videos.
- WirelessHD — Designed for graphic intensive applications such as high definition gaming.

 **NOTE:** Wireless display may not be supported on all computers.

## Hardware Requirements

	Intel Wireless Display	WirelessHD
<b>Transmitter</b>	Intel Centrino wireless WLAN card	SiBeam WirelessHD 60 GHz card
<b>Receiver</b>	Push2TV adapter for Intel Wireless Display	WirelessHD receiver kit

## Set Up WirelessHD (Optional)

The WirelessHD feature allows you to share high-definition video from your computer display to a TV without the use of cables. To set up WirelessHD, use a WirelessHD receiver kit. For instructions on setting up WirelessHD, see the document that shipped with your WirelessHD receiver kit.

 **NOTE:** The WirelessHD receiver kit does not ship with your computer and must be purchased separately.

If your computer supports the WirelessHD feature, the WiHD Application Controller icon  will be available on the Windows desktop.

 **NOTE:** You may have to set up WirelessHD receiver kit before you set up WirelessHD. For more information on setting up the WirelessHD receiver kit, see the document that shipped with the WirelessHD receiver kit.

To set up WirelessHD:

1. Turn on your computer.
2. Ensure that wireless is enabled on your computer.
3. Double-click the WiHD Application Controller icon  on the desktop. The **WirelessHD Application Controller** window appears.
4. Follow the instructions on screen.

# Set Up Intel Wireless Display (Optional)

 **NOTE:** It is recommended to use WirelessHD instead of Intel Wireless display for graphic-intensive applications as there may be a slight delay between the user input and on-screen display.

To set up wireless display:

1. Turn on your computer.
2. Ensure that wireless is enabled. For more information, see “Using the Wireless Control” on page 44.

 **NOTE:** The wireless display adapter does not ship with your computer and must be purchased separately.

3. Connect the wireless display adapter to the TV.
4. Turn on the TV and the wireless display adapter.
5. Select the appropriate video source for your TV, such as HDMI1, HDMI2, or S-Video.
6. Click the Intel Wireless Display icon  on the desktop.  
The **Intel Wireless Display** window appears.
7. Select **Scan for available displays**.
8. Select your wireless display adapter from the **Detected wireless displays** list.
9. Enter the security code that appears on your TV.

# Connect to the Internet (Optional)

## Setting Up a Wired Connection

- If you are using a dial-up connection, connect the telephone line to the optional external USB modem and to the telephone wall jack before you set up your Internet connection.
- If you are using a DSL or cable/satellite modem connection, contact your ISP or cellular telephone service provider for setup instructions.

To complete setting up your wired Internet connection, follow the instructions in “Setting Up Your Internet Connection” on page 21.

### Setting Up a Wireless Connection

 **NOTE:** To set up your wireless router, see the documentation that shipped with your router.

Before you can use your wireless Internet connection, you need to connect to your wireless router.

To set up your connection to a wireless router:

1. Ensure that wireless is enabled on your computer.
2. Save and close any open files, and exit any open programs.
3. Click **Start**  → **Control Panel**.
4. In the search box, type `network`, and then click **Network and Sharing Center** → **Connect to a network**.
5. Follow the instructions on the screen to complete the setup.

## Setting Up Your Internet Connection

ISPs and ISP offerings vary by country. Contact your ISP for offerings available in your country.

If you cannot connect to the Internet but have successfully connected in the past, the Internet Service Provider (ISP) might have a service outage. Contact your ISP to check the service status, or try connecting again later.

Have your ISP information ready. If you do not have an ISP, the **Connect to the Internet** wizard can help you get one.

1. Save and close any open files, and exit any open programs.
2. Click **Start**  → **Control Panel**.
3. In the search box, type `network`, and then click **Network and Sharing Center** → **Set up a new connection or Network** → **Connect to the Internet**.

The **Connect to the Internet** window appears.

-  **NOTE:** If you do not know which type of connection to select, click **Help me choose** or contact your ISP.
4. Follow the instructions on the screen and use the setup information provided by your ISP to complete the setup.





አሁን ለምሳሌ ለምሳሌ ለምሳሌ  
አሁን ለምሳሌ ለምሳሌ ለምሳሌ

## CHAPTER 2: GETTING TO KNOW YOUR LAPTOP





## CHAPTER 2: GETTING TO KNOW YOUR LAPTOP

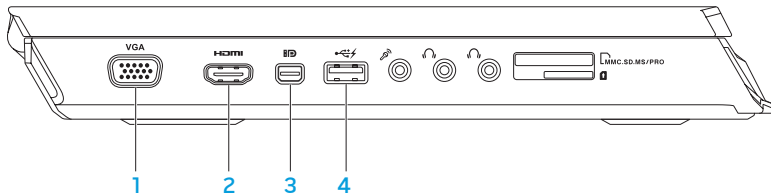

This chapter provides information about your new laptop to familiarize you with its various features, and get you up and running quickly.

### Left View Features



- 1  **VGA connector** — Connects your computer to a monitor or projector.
- 2  **HDMI connector** — Connects to a TV for both multi-channel digital audio and video signals.

**NOTE:** For a monitor without built-in speakers, only the video signal will be read.

- 3  **Mini-DisplayPort connector** — Connects your computer to external DisplayPort monitors and projectors.
- 4  **USB 2.0 connector with PowerShare** — Connects to USB devices, such as a mouse, keyboard, printer, external drive, or MP3 player.

The USB Powershare feature allows you to charge USB devices when the computer is powered on/off or in sleep state.

**NOTE:** Certain USB devices may not charge when the computer is powered off or in sleep state. In such cases, turn on the computer to charge the device.

**NOTE:** You can enable or disable the option of charging the USB devices when the computer is powered off or in sleep mode using the BIOS settings.

**NOTE:** If you turn off your computer while charging a USB device, the device stops charging. To continue charging, disconnect the USB device and connect it again.

**NOTE:** The USB PowerShare is automatically shut off when only 10% of the total battery life remains.

## CHAPTER 2: GETTING TO KNOW YOUR LAPTOP

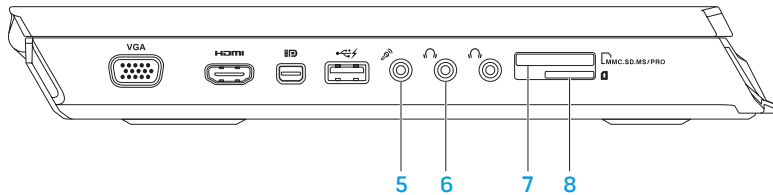

- 5  **Microphone connector** — Connects to a microphone or inputs signal for use with audio programs.

**NOTE:** You can set up 5.1 channel speakers by using the three audio connectors available on your computer.

- 6  **Headphone connectors (2)** — Connect to a pair of headphones or to a powered speaker or sound system.

- 7  **9-in-1 Media Card Reader** — Provides a fast and convenient way to view and share digital photos, music, videos, and documents.

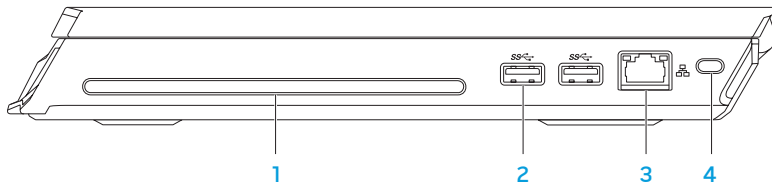

- 8  **SIM Card Reader** — Connects your computer to the Internet. To access the Internet you must be within the network of your cellular service provider.

## Right View Features



- 1 **Optical drive** — Plays or records only standard-size (12 cm) CDs and DVDs. Ensure that the side with print or writing is facing upward when inserting discs.

**NOTE:** Do not use non-standard-size or shape discs (including mini-CDs and mini-DVDs) as you will damage the drive.

- 2  **USB 3.0 connectors (2)** — Provide faster data transmission between your computer and USB devices.
- 3  **Network connector** — Connects your computer to a network or broadband device.
- 4 **Security cable slot** — Attaches a commercially available security cable to the computer.

**NOTE:** Before you buy a security cable, ensure that it fits into the security cable slot on your computer.

## Back View Features

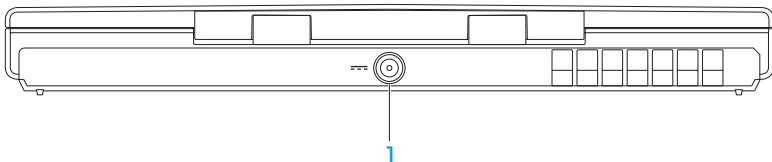

-  **AC adapter connector** — Connects to an AC adapter to power the computer and charge the battery.

## Display Features

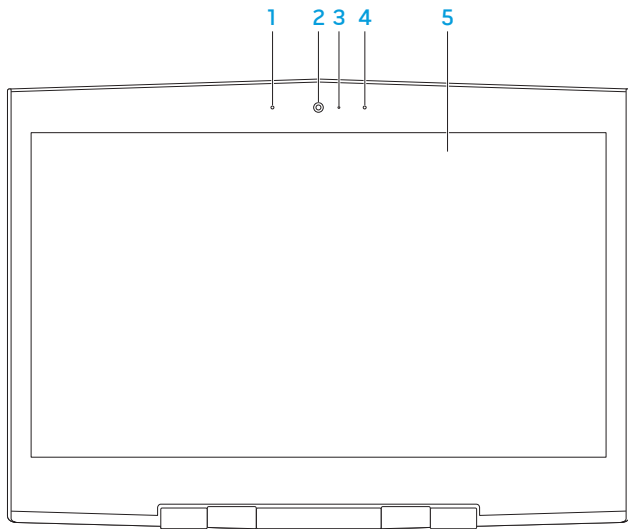



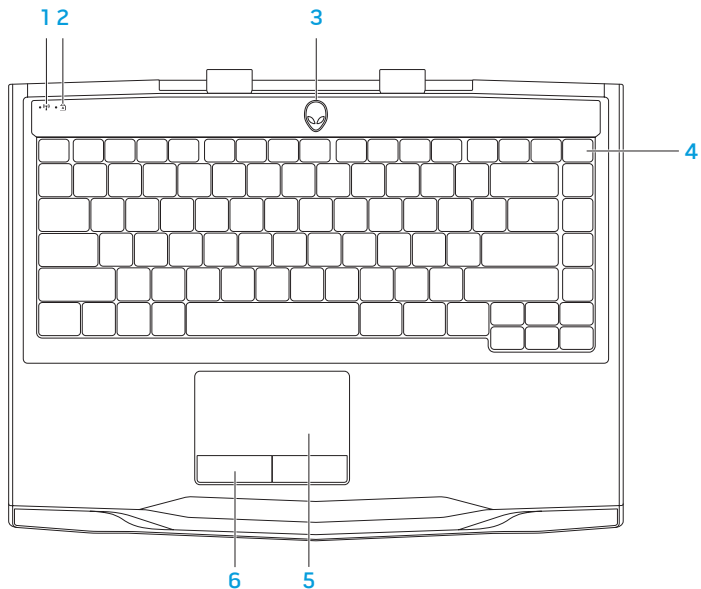

- 1 **Left digital-array microphone** — Combines with the right digital-array microphone to provide high quality sound for video chatting and voice recording.
- 2 **Camera** — Built-in camera for video capture, conferencing, and chat.
- 3 **Camera activity indicator** — Indicates if the camera is on or off. A solid white light indicates camera activity.
- 4 **Right digital-array microphone** — Combines with the left digital-array microphone to provide high quality sound for video chatting and voice recording.
- 5 **Display** — Your display can vary based on selections you made when purchasing your computer.

## Computer Base and Keyboard Features



-  **Wireless status light** — Turns on if wireless radios are enabled. For more information, see “Using the Wireless Control” on page 44.
-  **Caps lock status light** — Turns on when the keyboard is in Caps Lock mode. In this mode, all characters you type appear in uppercase on the screen.
- Power button** — Turns the computer on or off when pressed. For more information, see “Power Button” on page 34.
- Backlit Keyboard** — Illuminates to provide visibility in low lit or dark environments. You can customize the colors and effects using the AlienFX software available in the Alienware Command Center. For more information, see “Alienware Command Center” on page 40.
- Touch pad** — Provides the functionality of a mouse to move the cursor, drag or move selected items, and left-click by tapping the surface.
- Touch pad buttons (2)** — Provide left-click and right-click functions like those on a mouse.

# Power Button

You can program this button to perform actions like shutting down the operating system or entering the standby mode. For details on how to program this button, see **Power Options** in the control panel of Microsoft Windows operating system.

The power button is located in the center of the hinge cover. For the exact location, see “Computer Base and Keyboard Features” on page 32.

The color of the AlienHead rim indicates the power status. The color indicating the power status can be changed using the AlienFX software.



### On AC adapter:

Blue or custom AC-color

The battery is fully charged.

Blue or custom AC-color fading into amber or custom battery-color

The computer is turned off or on and the battery is charging.

Blue or custom AC-color fading into black

The computer is in standby mode.

### On battery:

Amber or custom battery-color

The battery is fully charged.

Amber or custom battery-color fading into black

The computer is in standby mode.

Blinking Amber or custom battery-color

The battery charge is low.

For more details on standby and hibernate mode, see **Power Options** in the control panel of your Microsoft Windows operating system.

# Function Keys

 **NOTE:** Depending on the configuration of the laptop you purchased, some of the function keys may have no associated tasks.

The <Fn> key is located near the bottom-left corner of the keyboard, and is used together with other keys to activate certain functions. Hold down the <Fn> key along with the key described below:



### F1 — Extend desktop

Press <Fn><F1> to open the screen resolution panel to extend your desktop to an external monitor and also change the display settings.



### F2 — Manage power settings

Press <Fn><F2> to manage the power setting using the AlienFusion software available in the Alienware Command Center (for more information, see “Alienware Command Center” on page 40).



### F3 — Wireless control - Switch wireless radio(s) on/off

Press <Fn><F3> to enable or disable the wireless radios(s) (for more information, see “Using the Wireless Control” on page 44).



### F4 — Increase display brightness

Press <Fn><F4> to increase the brightness of the display.

**F5 — Decrease display brightness**

Press <Fn><F5> to decrease the brightness of the display.

**F6 — Eject**

Press <Fn><F6> to eject the disc from the optical drive.

**F7 — Mute sound playback**

Press <Fn><F7> to mute or unmute the sound.

**F8 — Decrease volume**

Press <Fn><F8> to decrease the volume level.

**F9 — Increase volume**

Press <Fn><F9> to increase the volume level.

**F10 — Rewind or play previous track**

Press <Fn><F10> to rewind or play previous track.

**F11 — Play or pause**

Press <Fn><F11> to play or pause a track.

## CHAPTER 2: GETTING TO KNOW YOUR LAPTOP



### F12 — Fast Forward or Play next track

Press <Fn><F12> to fast forward or play the next track.



### PAUSE — Alienware Command Center

Press <Fn><PAUSE> to access Alienware Command Center (for more information, see "Alienware Command Center" on page 40).



### PRT SCRN — AlienFX

Press <Fn><PRT SCRN> to enable or disable the AlienFX illumination.



### INSERT — Touch Pad control

Press <Fn><INSERT> to enable or disable the touch pad.

**NOTE:** The illuminated lighting will remain on even when the touch pad is disabled.



አዲስ አበባ ፎካል ስኬል

## CHAPTER 3: USING YOUR LAPTOP

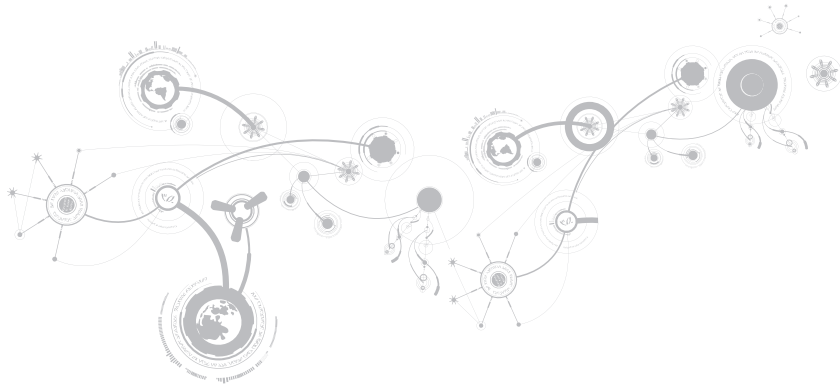

# Alienware Command Center

The Alienware Command Center gives you access to Alienware's exclusive software and is a continuously upgradable control panel. As Alienware releases new programs, they download directly into the Command Center allowing you to build a library of system management, optimization, and customization tools. You can access Alienware Command Center by pressing <Fn><PAUSE> on the function keys. For more information, see "Function Keys" on page 36.









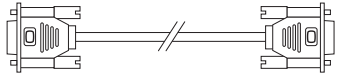
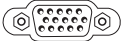

# Connecting External Displays

If you want to enjoy your computing environment on a bigger scale visually, or extend your desktop area, you can connect an external display such as a standalone monitor, an LCD TV, or a projector.

## Connecting a Display

Use the appropriate cable based on the connectors available on your computer and display. Refer to the following table to identify the connectors on your computer and display.

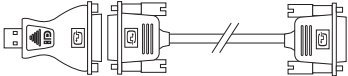
 **NOTE:** When connecting to a single display, connect the display to ONLY ONE of the connectors on your computer.

Connection Type	Computer	Cable	Display
VGA-to-VGA (VGA cable)			
HDMI-to-HDMI (HDMI cable)			
Mini-DisplayPort- to-DisplayPort (Mini-DisplayPort- to-DisplayPort adapter + DisplayPort Cable)			
Mini-DisplayPort- to-DVI (Mini- DisplayPort-to-DVI adapter + DVI cable)			

## CHAPTER 3: USING YOUR LAPTOP

 **NOTE:** You can purchase the mini-DisplayPort-to-DisplayPort and mini-DisplayPort-to-DVI adapters at [dell.com](https://www.dell.com).

1. Turn off your laptop.
2. Turn off the display and disconnect it from the power supply.
3. Connect one end of the display cable to the VGA, mini-DisplayPort, or HDMI connector on your Alienware laptop.
4. Connect the other end of the cable to the same connector on your display.
5. If necessary, connect one end of the power cable to the display's power connector.
6. Connect the other end of the power cable to a grounded three-prong power strip or wall outlet.
7. Turn on your laptop, and then turn on your display.

## Extending the Desktop

1. With the external display connected, right-click on the desktop and select **Screen resolution** or press the <Fn><F1> keys.
2. Customize the following options:
  - a. **Display** — Select the display you would like to manage.
  - b. **Resolution** — Select the suitable display resolution.
  - c. **Orientation** — Select **Potrait** or **Landscape** depending on your display type.
  - d. **Multiple Displays** — Select from the below options:
    - Duplicate these displays
    - Extend these displays
    - Show desktop on display 1
    - Show desktop on display 2
3. Click **Apply** to apply your changes and then click **OK** to exit.

## Using the Wireless Control

The wireless control allows you to quickly manage all of your wireless radio(s) (Bluetooth, WLAN, WWAN, and WirelessHD).

To enable/disable wireless:

1. Turn on your computer.
2. Press the <Fn><F3> keys.
3. In the pop-up window that appears, select the option(s) to enable wireless or clear the option(s) to disable wireless.
4. Click **OK**.

## Battery Pack

Your laptop is equipped with a high-energy rechargeable lithium polymer battery pack. Battery life will vary depending on your laptop configuration, model, applications installed, power management settings, and features used. As with all batteries, the maximum capacity of this battery will decrease with time and usage.

The battery meter lights on the battery pack indicate the charge level of the battery. When you press the battery meter once, the charge level lights illuminate. Each of the five lights represent approximately 20% of the total battery charge. For example, if four lights turn on, there is approximately 60 to 80% of battery charge remaining and if no lights turn on, there is no charge remaining in the battery.

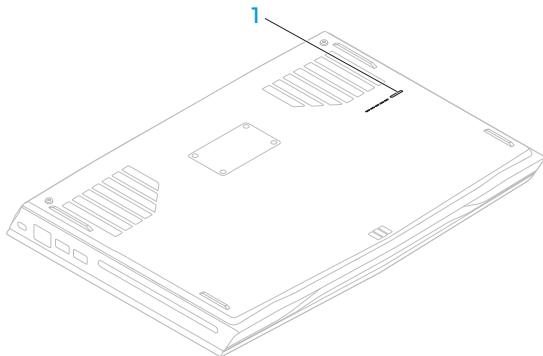

1 Battery Meter

# Power Management

## Understanding Power Consumption

In order to fully utilize the power of your battery, it would be a good idea for you to spend some time acquiring a basic understanding of the power management concept from your operating system.

You can use the power options in your operating system to configure the power settings on your computer. The Microsoft Windows operating system installed on your computer provides three default options:

- **Balanced** — Offers full performance when you need it and saves power during periods of inactivity.
- **Power Saver** — Saves power on your computer by reducing system performance to maximize the life of the computer and by reducing the amount of energy consumed by your computer over its lifetime.
- **High Performance** — Provides the highest level of system performance on your computer by adapting processor speed to your activity and by maximizing system performance.



## Customizing Your Power Settings

1. Click **Start**  → **Control Panel**.
2. Click **All Control Panel Items**.
3. Double-click the **Power Options** icon.
4. Select a power plan from the options shown. To customize specific settings, click **Change plan settings** next to the selected power plan.

## Reducing Power Consumption

Although your laptop (together with the operating system) is capable of power conservation, there are measures you can take to reduce the power consumption:

- Lower the intensity of the display backlight. A very bright screen translates to higher power usage.
- Use the **Go Dark** option in the Alienware Command Center.

# nVidia Optimus Technology

Your Alienware M14x laptop is equipped with nVidia Optimus technology. The Optimus technology is designed to maximize performance and user experience on your computer, while minimizing the impact on battery life. It enables you to combine the graphic processing capability of the integrated Intel graphic processing unit (GPU) with the discrete nVidia GPU while running graphic-intensive applications such as 3-D games. The nVidia GPU is turned on only for preset applications and thus extends the battery life.

The Optimus technology is enabled through an application profile. When an application is launched, the video drivers check to see if the application has a profile associated with it.

- If an application profile exists, the nVidia GPU is turned on and the application runs in performance mode. The nVidia GPU is turned off automatically when the application is closed.
- If an application profile does not exist, the integrated Intel GPU is used.

The default list of application profiles is updated frequently by nVidia and is automatically downloaded to your computer when you are connected to the Internet.

You can also create application profiles for any application on your computer. This may be required for newly released games or applications that do not have a default application profile.

## Changing the Application Profile Settings

1. Right-click on the desktop and select **NVIDIA Control Panel**.
2. In the **NVIDIA Control Panel** window, click **3D Settings** to expand the selection (if not already expanded) and then click **Manage 3D Settings**.
3. In the **Program Settings** tab, click **Add** and browse to select the application's executable file (.exe). Once added, you can change the settings for that application.

To change the settings for a specific application, locate the application in the **Select a program to customize:** list and make the desired changes.

 **NOTE:** For more information on the nVidia control panel options and settings, click **Help**.

### Free Fall Sensor

Free fall sensor protects your computer hard drive from possible damage, by detecting a free fall state caused by accidentally dropping the computer. When a free fall state is detected, the hard drive is placed in a safe state to protect against damage to the read/write head and possible data loss. Your hard drive returns to normal operation, when the free fall state is no longer detected.

### FastAccess Facial Recognition (Optional)

Your computer may have the FastAccess facial recognition feature. This feature helps keep your Alienware computer secure by using the unique appearance of your face to verify your identity and automatically supply login information that you would normally enter manually, such as a user ID and password for a Windows account or a secure web site. For more information, click **Start**  → **Programs** → **FastAccess**.

# Configuring the BIOS

## System Setup

The System Setup options allow you to:

- Change the system configuration information after you add, change, or remove any hardware in your laptop.
- Set or change a user-selectable option.
- View the installed amount of memory or set the type of hard drive installed.

Before you use System Setup, it is recommended that you write down the current System Setup information for future reference.

 **CAUTION: Do not change the settings in System Setup unless you are an expert computer user. Certain changes can cause your computer to work incorrectly.**

### Entering System Setup

1. Turn on (or restart) your laptop.

 **NOTE:** Keyboard failure may result when a key on the keyboard is held down for extended periods of time. To avoid possible keyboard failure, press and release <F2> in even intervals until the System Setup screen appears.

2. While the laptop is booting, press <F2> immediately before the operating system logo appears to access the **BIOS Setup Utility**.

If an error occurs during Power On Self Test (POST), you may also enter the **BIOS Setup Utility** by pressing <F2> when prompted.



 **NOTE:** If you wait too long and the operating system logo appears, continue to wait until you see the Microsoft Windows desktop, then shut down your laptop and try again.

### System Setup Screens

The **BIOS Setup Utility** window displays current or changeable configuration information for your laptop. Information is divided into five menus: **Main**, **Advanced**, **Security**, **Boot**, and **Exit**.

Key functions appear at the bottom of the **BIOS Setup Utility** window and lists keys and their functions within the active field.

## System Setup Options

-  **NOTE:** Depending on your computer and installed devices, the items listed in this section may not appear, or may not appear exactly as listed.
-  **NOTE:** For the updated system setup information, see the *Service Manual* at [support.dell.com/manuals](http://support.dell.com/manuals).

### Main Menu

---

System Time (hh:mm:ss)	Displays the system time.
System Date (mm/dd/yyyy)	Displays the system date.
Alienware	Displays the model number of your computer.
Service Tag	Displays the service tag of your computer.
BIOS Version	Displays the BIOS version.
EC Version	Displays the EC firmware version.
ME Version	Displays the Intel ME firmware version.
CPU	Displays the type of processor installed.
CPU Frequency	Displays the speed of the processor.

### Main Menu

---

CPU L3 Cache	Displays the processor cache size.
CPUID	Displays the ID of the processor.
Integrated Graphics	Displays the integrated graphics.
Discrete Graphics	Displays the discrete graphics.
Total Memory	Displays the total memory available in your computer.
Memory Bank 0	Displays the memory size installed in DIMM 0.
Memory Bank 1	Displays the memory size installed in DIMM 1.



## Advanced Menu

---

Intel SpeedStep	Allows you to enable or disable the Intel SpeedStep technology. Disabling this feature may improve performance, but will greatly reduce battery life.
Virtualization	Allows you to enable or disable the Intel Virtualization technology.
USB Emulation	<p>Allows you to enable or disable the USB emulation feature. This feature defines how the BIOS, in the absence of a USB-aware operating system, handles USB devices. USB emulation is always enabled during POST.</p> <p><b>NOTE:</b> You cannot boot any type of USB device (hard drive, or memory key) when this option is off.</p>
USB Wake Support	<p>Allows you to enable USB devices to wake the computer from standby or to disable the USB wake support feature.</p> <p><b>NOTE:</b> If USB Powershare is enabled, a device connected to the USB Powershare connector may not wake the computer.</p>

### Advanced Menu

---

USB Power Share	<p>Allows you to charge USB devices when the computer is turned off or in standby mode.</p> <ul style="list-style-type: none"><li>• AC Only: Charge USB devices when connected to AC adapter only.</li><li>• AC and Battery: Charge USB devices when connected to AC adapter and when the computer is running on battery.</li><li>• Disabled: Disables USB PowerShare.</li></ul>
Integrated Network	<p>Allows you to enable or disable the on-board LAN controller.</p> <ul style="list-style-type: none"><li>• Disabled: Internal LAN is disabled and is not visible to the operating system.</li><li>• Enabled: Internal LAN is enabled.</li></ul>
High Definition Audio	<p>Allows you to enable or disable the internal high definition audio device.</p> <ul style="list-style-type: none"><li>• Disabled: The internal audio device is disabled and is not visible to the operating system.</li><li>• Enabled: The internal audio device is enabled.</li></ul>
SD Card Reader	<p>Allows you to enable or disable the internal SD card reader.</p>

## Advanced Menu

---

Performance Options	Allows you to configure fields in the Performance Options sub-menu (for more information, see “Advanced — Performance Options Menu” on page 58).
SATA Operation	Allows you to configure the operating mode of the integrated SATA hard drive controller. <ul style="list-style-type: none"><li>• AHCI: SATA is configured for AHCI mode.</li><li>• RAID: SATA is configured for RAID mode.</li></ul>
SATA HARD DRIVE 1	Displays the installed SATA hard drive model.
Adapter Warnings	Allows you to choose if the computer should display warning messages when you use AC adapters that are not supported by your computer. <ul style="list-style-type: none"><li>• Disabled: BIOS will not detect unsupported A/C adapters and will not display any message to screen.</li><li>• Enabled : BIOS will detect unsupported A/C adapters and display an error to screen.</li></ul>
Charger Behavior	Allows you to enable or disable battery charging.

### Advanced — Performance Options Menu

---

CPU Turbo Mode	Allows you to enable or disable the Intel CPU turbo mode performance option.
Overclocking Features	Allows you to enable or disable the global overclocking feature. <ul style="list-style-type: none"><li>• Disabled: The overclocking feature is disabled.</li><li>• Enabled: Displays additional overclocking options.</li></ul>
Override Turbo settings	Allows you to override CPU turbo mode settings.
Long Duration Power Limit	Allows you to set the turbo mode power limit 1 value in watts.
Long Duration Time Window	Allows you to set the turbo mode time 1 value in seconds.
Short Duration Power Limit	Allows you to enable or disable short duration power limit.
Short Duration Time Window	Allows you to set the turbo mode power limit 2 value in watts.
Bus Clock	
Current Frequency	Displays the current bus clock frequency.

## Advanced — Performance Options Menu

---

New Frequency in 10KHz increments	Allows you to enter a new bus clock frequency in 10 Khz increments.
Apply New Bus Clock Frequency	Allows you to apply the new bus clock frequency <ul style="list-style-type: none"><li>• Immediately: The new bus clock frequency is applied immediately.</li><li>• Once: The new bus clock frequency is applied once until the next reboot.</li><li>• Permanently: The new bus clock frequency is applied permanently after the next reboot.</li></ul>
Memory Overclocking	
Memory Override Support	Allows you to enable or disable the memory override option support. <ul style="list-style-type: none"><li>• Disabled: The memory override support is disabled.</li><li>• Enabled: Displays additional memory override support options.</li></ul>
Memory Voltage	Allows you to increase memory voltage.
Memory Frequency	Allows you to set memory frequency.
XMP DIMM Profile	Allows you to configure different XMP options.

### Wireless Menu

---

Bluetooth	Allows you to enable or disable the internal Bluetooth device. <ul style="list-style-type: none"><li>• Disabled: The internal Bluetooth device is disabled and is not visible to the operating system.</li><li>• Enabled: The internal Bluetooth device is enabled.</li></ul>
Wireless Network	Allows you to enable or disable the internal wireless device. <ul style="list-style-type: none"><li>• Disabled: The internal wireless device is disabled and is not visible to the operating system.</li><li>• Enabled: The internal wireless device is enabled.</li></ul>
WWAN	Allows you to enable or disable the internal WWAN device. <ul style="list-style-type: none"><li>• Disabled: The internal WWAN device is disabled and is not visible to the operating system.</li><li>• Enabled: The internal WWAN device is enabled.</li></ul>
Wireless Switch/ Hotkey	Allows you to disable all internal wireless devices.

## Security Menu

---

Supervisor Password	Displays if the supervisor password is clear or set.
User Password	Displays if the user password is clear or set.
Set Service Tag	Displays the service tag of the computer when the service tag is present.  Displays a field to input the service tag manually when the service tag is absent.
Set Supervisor Password	Allows you to set the supervisor password. The supervisor password controls access to the system setup utility.
Set User Password	Allows you to set the user password. The user password controls access to the computer at boot.
Computrace	Allows you to enable or disable Computrace security feature.

### Boot Menu

---

Use the up or down arrow keys to change the boot device priority. You can choose from:

- Hard Drive
- USB Storage
- CD/DVD
- Removal Devices
- Network



## Exit Menu

---

Exit Saving Changes	Allows you to exit System Setup and save your changes to CMOS.
Save Change Without Exit	Allows you remain in System Setup and save your changes to CMOS.
Exit Discarding Changes	Allows you to exit System Setup and load previous values from CMOS for all Setup items.
Load Optimal Defaults	Allows you to load default values for all Setup items.
Discard Changes	Allows you to load previous values from CMOS for all Setup items.



አሁን ለዚህ ገጽ ለማግኘት የሚያስፈልገውን  
የሰነድ አይነት ይምረጡ

## CHAPTER 4: INSTALLING AND REPLACING COMPONENTS

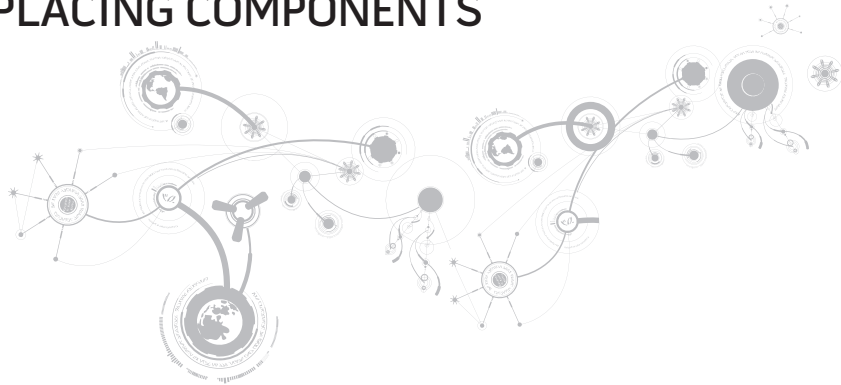

## CHAPTER 4: INSTALLING AND REPLACING COMPONENTS

This chapter provides guidelines and instructions for increasing the processing power by upgrading equipment. You can purchase components for your computer at **dell.com** or **alienware.com**.

 **NOTE:** See the *Service Manual* at **support.dell.com/manuals** for installation instructions of all serviceable components.

### Before You Begin

This section provides procedures for removing and installing the components in your laptop. Unless otherwise noted, each procedure assumes that the following conditions exist:

- You have performed the steps in “Turning Off Your Computer” and “Before Working Inside Your Computer” in this section.
- You have read the safety information that shipped with your computer.
- A component can be replaced or—if purchased separately—installed by performing the removal procedure in reverse order.

The procedures in this section may require the following tools:

- Small flat-blade screwdriver
- Phillips screwdriver

## Turning Off Your Computer

 **CAUTION:** To avoid losing data, save and close all open files and exit all open programs before you turn off your laptop.





1. Save and close all open files and exit all open programs.
2. Click **Start**  → **Shut Down**.

The laptop turns off after the operating system shutdown process finishes.

3. Ensure that the computer and any attached devices are turned off. If your computer and attached devices did not automatically turn off when you shut down your operating system, press and hold the power button for at least 8 to 10 seconds until the computer turns off.

# Before Working Inside Your Computer

Use the following safety guidelines to help protect your computer from potential damage and to help to ensure your own personal safety.

-  **WARNING:** Before working inside your laptop, read the safety information that shipped with your computer. For additional safety best practices information, see the Regulatory Compliance Homepage at [dell.com/regulatory\\_compliance](http://dell.com/regulatory_compliance).
-  **CAUTION:** Handle components and cards with care. Do not touch the components or contacts on a card. Hold a card by its edges. Hold a component such as a processor by its edges, not by its pins.
-  **CAUTION:** Only a certified service technician should perform repairs on your computer. Damage due to servicing that is not authorized by Dell is not covered by your warranty.
-  **CAUTION:** To avoid electrostatic discharge, ground yourself by using a wrist grounding strap or by periodically touching an unpainted metal surface (such as a connector on the back of the computer).
-  **CAUTION:** When you disconnect a cable, pull on its connector or on its pull-tab, not on the cable itself. Some cables have connectors with locking tabs; if you are disconnecting this type of cable, press in on the locking tabs before you disconnect the cable. As you pull connectors apart, keep them evenly aligned to avoid bending any connector pins. Also, before you connect a cable, ensure that both connectors are correctly oriented and aligned.

**△ CAUTION: To avoid damaging the computer, perform the following steps before you begin working inside the computer.**

1. Ensure that the work surface is flat and clean to prevent the computer cover from being scratched.
2. Turn off your computer (for more information, see “Turning Off Your Computer” on page 67).

**△ CAUTION: To disconnect a network cable, first unplug the cable from your computer and then unplug the cable from the network device.**

3. Disconnect all telephone or network cables from the laptop.
4. Press and eject any installed cards from the Media Card Reader.
5. Disconnect your computer and all attached devices from their electrical outlets.

**△ CAUTION: To help prevent damage to the system board, you must remove the battery from the battery bay before you service the laptop.**

6. Remove the battery from the battery bay (for more information, see “Replacing the Battery Pack” on page 70).
7. Press the power button to ground the system board.

# Replacing the Battery Pack

The battery pack can easily be removed and replaced. Ensure that the laptop is properly shut down before changing the battery pack.

 **CAUTION: To avoid damage to the laptop, use only the battery designed for this particular Alienware laptop. Do not use batteries designed for other Alienware or Dell laptops.**

To remove the battery pack:

1. Follow the instructions in “Before You Begin” on page 66.
2. Shut down the laptop and turn it over.
3. Loosen the two captive screws that secure the base cover to the computer base.
4. Slide and lift the base cover off the computer base.



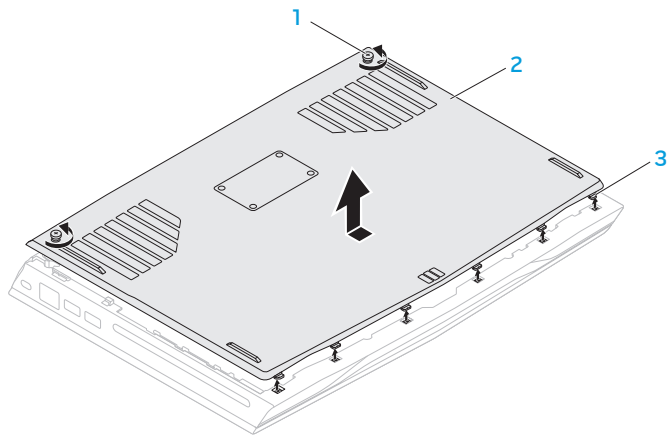

1 captive screws (2)

3 tabs (6)

2 base cover

## CHAPTER 4: INSTALLING AND REPLACING COMPONENTS

5. Loosen the two captive screws that secure the battery pack to the computer base.
6. Disconnect the battery pack cable from the connector on the system board.
7. Lift the battery pack off the computer base.

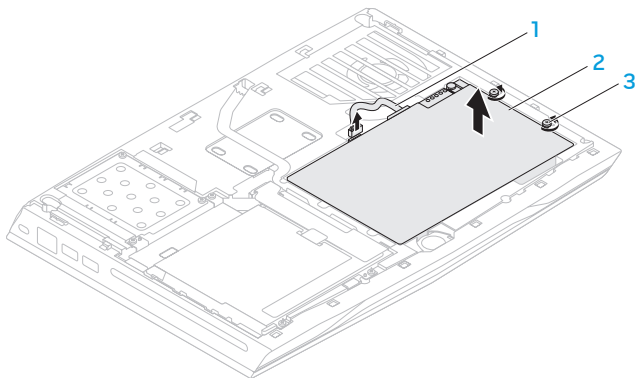

1 battery pack cable

3 captive screws (2)

2 battery pack

To replace the battery pack:

1. Follow the the instructions in “Before You Begin” on page 66.
2. Place the battery pack in the battery bay and tighten the two captive screws that secure the battery pack to the computer base.
3. Connect the battery pack cable to the connector on the system board.
4. Align the tabs on the base cover with the slots on the computer base.
5. Slide the base cover until it clicks into place.
6. Tighten the two captive screws that secure the base cover to the computer base.

## Upgrading or Replacing Memory

Your laptop is equipped with a configurable memory unit. The industry standard JEDEC PC3-12800 (DDR3-1600) SODIMM memory module connectors are available for memory upgrade. The table below illustrates all the possible ways system memory can be configured.

Memory connector #1	Memory connector #2	Total memory
1 GB	1 GB	2 GB
1 GB	2 GB	3 GB
2 GB	2 GB	4 GB
2 GB	4 GB	6 GB
4 GB	4 GB	8 GB

## Removing the Memory Module(s)

1. Follow the instructions in “Before You Begin” on page 66.
2. Shut down the laptop and turn it over.
3. Loosen the two captive screws that secure the base cover to the computer base.
4. Slide and lift the base cover off the computer base.
5. Remove the battery (see “Replacing the Battery Pack” on page 70).
6. Loosen the two captive screws that secure the memory-module cover to the computer base.
7. Lift the memory-module cover away from the computer.

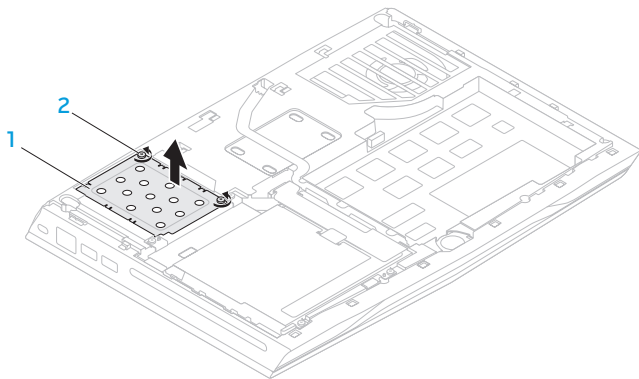

**1** memory-module cover    **2** captive screws (2)

8. Use your fingertips to carefully spread apart the memory module connector's spring-locks until the module pops up.
9. Remove the memory module.

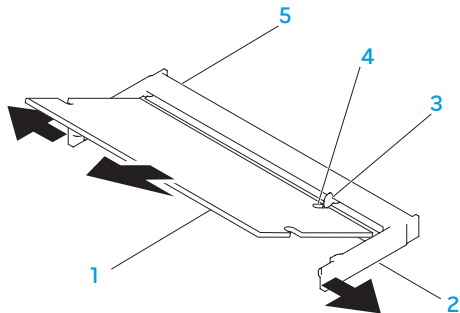

1 memory module

2 spring locks (2)

3 tab

4 notch

5 memory module connector

To replace the memory modules, perform the removal steps in reverse order. While inserting the memory module into the connector align the notch on the memory module with the tab on the memory module connector.

 **NOTE:** If you need to install memory modules in two connectors, install a memory module in the lower connector before you install a memory module in the upper connector.

 **NOTE:** If the memory module is not installed properly, the computer may not boot.





ህዝብ ለግንባር ለግንባር

## CHAPTER 5: TROUBLESHOOTING

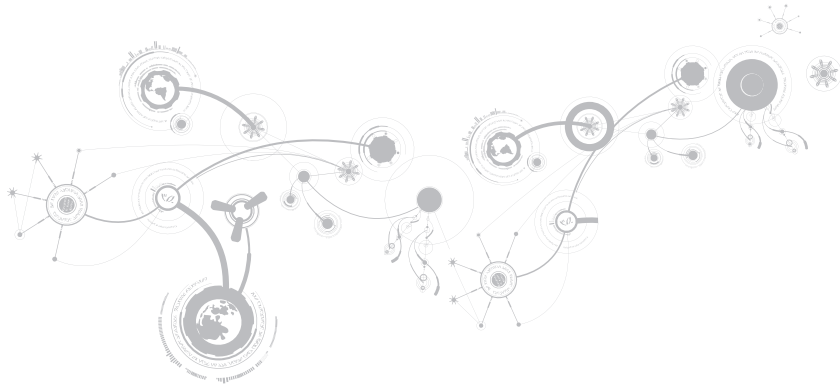

# Basic Hints and Tips

- Computer does not power on: Is your AC adapter cable securely connected to a working electrical outlet? If connected to a power strip, ensure that the strip is actually working.
- Connections: Check all the cables to ensure that there are no loose connections anywhere.
- Power Savings: Ensure that your computer is not in hibernate or standby mode by pressing the power button for less than 4 seconds. The power status light will fade from blue to black while in standby mode; in hibernate mode it will be off.
- Brightness: Check and adjust the brightness of the display by pressing the key combinations <Fn><F4> or <Fn><F5>.
- Display Choice: Press the key combination <Fn><F1> to ensure that the computer is not set to "External Only" display.
- Use only the AC adapter that shipped with your laptop.

## Backup and General Maintenance

- Always back up your important data on a regular basis and keep copies of your operating system and software safe. Do not forget to note the serial numbers if you are storing them outside of their original cases - for example, in a CD wallet.
- Run maintenance programs as often as you can. You may schedule these programs to run at times when you are not using your computer. You can use those provided with your operating system, or buy more powerful, dedicated programs to do so.
- Write down your passwords and keep them safe (away from your computer). This is especially important if you choose to password-protect your computer's BIOS and operating system.
- Document vital settings such as network, dialup, mail and Internet settings.

### *When troubleshooting your computer, remember the following safety guidelines:*

- Before touching any of the computer's internal components, touch an unpainted portion of the chassis. Doing so will safely discharge any static electricity, which could damage your computer.
- Turn off your computer and any connected peripherals.
- Disconnect any peripherals from your computer.

### *Things to check:*

- Ensure that the AC adapter cable is properly connected between your computer and a grounded, three-prong power outlet. Ensure that the power outlet is working.
- Ensure the UPS or power strip is turned on (if applicable).
- If your peripheral devices (for example keyboard, mouse, printer, and so on) are not working, ensure that all connections are secure.
- If any computer components were added or removed before the problem began, check to see if you performed the installation or removal procedures properly.
- If an error message appears on the screen, write down the exact error message prior to calling Alienware Technical Support to aid in diagnosing and resolving your issue.
- If an error occurs in a specific program, see the program's documentation.

# Software Diagnostic Tools

## Enhanced Pre-Boot System Assessment (ePSA)

The computer runs the Enhanced Pre-boot System Assessment (ePSA), a series of initial tests of your system board, keyboard, display, memory, hard drive, etc.

To invoke ePSA:

1. Turn on (or restart) your computer.
2. When the Alienware logo appears, press <F12> immediately.

 **NOTE:** If you wait too long and the operating system logo appears, continue to wait until you see the Microsoft Windows desktop; then, shut down your computer and try again.

3. Select **Diagnostics** from the menu and press <Enter>.

## CHAPTER 5: TROUBLESHOOTING

During the assessment, answer any questions that appear.

- If a failure is detected, the computer stops and beeps. To stop the assessment and restart the computer, press <n>; to continue to the next test, press <y>; to retest the component that failed, press <r>.
- If failures are detected during the Enhanced Pre-boot System Assessment, write down the error code(s) and contact Alienware (for more information, see "Contacting Alienware" on page 117).

If the Enhanced Pre-boot System Assessment completes successfully, the following message appears "Do you want to run the remaining memory tests? This will take about 30 minutes or more. Do you want to continue? (Recommended)."

If you are experiencing memory issues, press <y>, otherwise press <n>. The following message is displayed: "Enhanced Pre-boot System Assessment complete."

Press <o> to reboot your computer.

# Answers to Common Problems

## Computer Startup Problems

### The computer fails the POST

The Power On Self Test (POST) ensures that the computer meets all the necessary system requirements and that all hardware is working properly before starting the remainder of the boot process. If the computer passes the POST, the computer will continue to start normally. However, if the computer fails the POST, the computer will generate a single beep to indicate a general failure and an error message will be displayed. For assistance, contact Alienware Technical Support (see “Contacting Alienware” on page 117).

### The computer stops responding or a solid blue screen appears

 **CAUTION:** You might lose data if you are unable to perform an operating system shutdown.

If you are unable to get a response by pressing a key on your keyboard or moving your mouse, press and hold the power button for at least 6 seconds until the computer turns off, then restart your computer.

 **NOTE:** The chkdsk program may run when you restart the computer. Follow the instructions on the screen.

## Software Problems

### A program stops responding or crashes repeatedly

End the program:

1. Press <Ctrl><Shift><Esc> simultaneously.
2. Click the **Applications** tab and select the program that is no longer responding.
3. Click **End Task**.

Check the software documentation.

If necessary, uninstall and then reinstall the program.

### A program is designed for an earlier version of Microsoft Windows

Run the Program Compatibility Wizard:

The **Program Compatibility Wizard** configures a program so that it runs in an environment similar to an earlier version of Microsoft Windows operating system environments.

1. Click **Start**  → **Control Panel** → **Programs** → **Programs and Features** → **Use an older program with this version of Windows**.
2. In the welcome screen, click **Next**.
3. Follow the instructions on the screen.



## Other software problems

**Back up your files immediately**

**Use a virus-scanning program to check the hard drive, or CDs**

**Save and close any open files or programs and shut down your computer through the Start menu**

**Scan the computer for spyware:**

If you are experiencing slow computer performance, you frequently receive pop-up advertisements, or you are having problems connecting to the Internet, your computer might be infected with spyware. Use an anti-virus program that includes anti-spyware protection (your program may require an upgrade) to scan the computer and remove spyware.

**Run the ePSA Diagnostics:**

If all tests run successfully, the error condition is related to a software problem.

## CHAPTER 5: TROUBLESHOOTING

**Check the software documentation or contact the software manufacturer for troubleshooting information:**

- Ensure that the program is compatible with the operating system installed on your computer.
- Ensure that your computer meets the minimum hardware requirements needed to run the software. See the software documentation for information.
- Ensure that the program is installed and configured properly.
- Verify that the device drivers do not conflict with the program.
- If necessary, uninstall and then reinstall the program.

## Hard Drive Problems

### Allow the computer to cool before turning it on

A hot hard drive may prevent the operating system from starting. Try allowing the computer to return to room temperature before turning it on.

### Run Check Disk

1. Click **Start**  → **Computer**.
2. Right-click **Local Disk C:**.
3. Click **Properties** → **Tools** → **Check Now**.  
If the **User Account Control** window appears, click **Continue**.
4. Follow the instructions on the screen.

# Memory Problem

## Memory errors detected on startup

Check memory modules for correct seating and orientation. Reseat the memory modules if applicable (see "Upgrading or Replacing Memory" on page 74).

# Display Problem

## If the display is blank

 **NOTE:** If you are using a program that requires a higher resolution than your computer supports, it is recommended that you attach an external monitor to your computer.

### **The computer may be in a power saving mode:**

Press a key on the keyboard or press the power button to resume normal operation.

### **Switch the video image:**

If your computer is attached to an external monitor, press <Fn><F1> to switch the video image to the display.

## Power Problem

### When you press the power button, the computer does not turn on

- If the AC adapter cable is connected to a surge protector or UPS, ensure that the surge protector or UPS is securely connected to an electrical outlet, is switched on and is working correctly.
- Check that the wall outlet is working properly by testing another device such as a radio or lamp that you know works. If the wall outlet is not working, contact an electrician or your power company for further assistance.
- If the problem persists, contact Alienware support (see “Contacting Alienware” on page 117).



የአዲስ አበባ ዩኒቨርሲቲ

## CHAPTER 6: SYSTEM RECOVERY



## AlienRespawn

- △ **CAUTION:** Using AlienRespawn permanently removes any programs or drivers installed after you received your computer. Create backup media of applications you need to install on your computer before using AlienRespawn. Use AlienRespawn only if System Restore did not resolve your operating system problem.
- △ **CAUTION:** Although AlienRespawn is designed to preserve the data files on your computer, it is recommended that you backup your data files before using AlienRespawn.

You can use AlienRespawn to restore your hard drive to the operating state it was in when you purchased your computer, while preserving the data files.

AlienRespawn allows you to backup and restore your computer to an earlier operating state.



## AlienRespawn Basic

To restore the factory image while preserving the data files:

1. Turn off your computer.
2. Disconnect all the devices connected to the computer (such as USB drive, printer, and so on) and remove any recently added internal hardware.

 **NOTE:** Do not disconnect the AC adapter cable.

3. Turn on your computer.
4. When the Alienware logo appears, press <F8> several times to access the **Advanced Boot Options** window.

 **NOTE:** If you wait too long and the operating system logo appears, continue to wait until you see the Microsoft Windows desktop; then, shut down your computer and try again.

5. Select **Repair Your Computer**.
6. Select **AlienRespawn and Emergency Backup** from the **System Recovery Options** menu and follow the instructions on the screen.

 **NOTE:** The restoration process may take an hour or more depending on the size of the data to be restored.

 **NOTE:** For more information on AlienRespawn, see the knowledge base article 353560 at [support.dell.com](http://support.dell.com).

## Upgrading to AlienRespawn Professional

AlienRespawn provides additional features that allow you to:

- Backup and restore your computer based on file types
- Backup files to a local storage device
- Schedule automated backups

To upgrade to AlienRespawn Professional:

1. Double-click the AlienRespawn icon  in the notification area of your desktop.
2. Click **Upgrade Now!**
3. Follow the instructions on the screen.

## Dell DataSafe Online Backup (Optional)

 **NOTE:** Dell DataSafe Online is supported only on Windows operating systems.

 **NOTE:** A broadband connection is recommended for fast upload or download speeds.

Dell DataSafe Online is an automated backup and recovery service that helps protect your data and other important files from catastrophic incidents like theft, fire, or natural disasters. You can access the service on your computer using a password-protected account.

For more information, go to **delldatasafe.com**.

To schedule backups:

1. Double-click the Dell DataSafe Online icon  on the taskbar.
2. Follow the instructions that appear on the screen.

# My Dell Downloads

 **NOTE:** My Dell Downloads may not be available in all regions.

Some of the software pre-installed on your new Dell or Alienware computer do not include a backup CD or DVD. This software is available on the My Dell Downloads website. From this website you can download available software for reinstallation or create your own backup media.

To register and use My Dell Downloads:

1. Go to **[DownloadStore.dell.com/media](https://DownloadStore.dell.com/media)**.
2. Follow the instructions on the screen to register and download the software.
3. Reinstall the software or create a backup media for future use.

አዲስ አበባ ዩኒቨርሲቲ ፡ የኢንፎርሜሽን ቴክኖሎጂ ትምህርት ቤቅ

## CHAPTER 7: SPECIFICATIONS

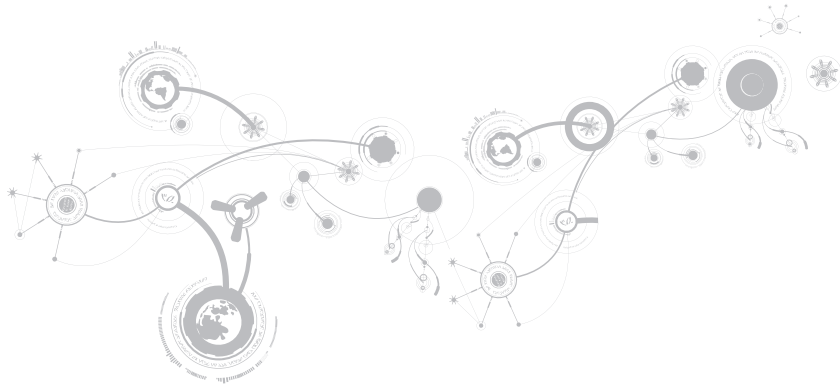

### Computer Model

---

Alienware M14x

### Dimensions

---

Height

Front 37.80 mm (1.49 inches)

Back 37.80 mm (1.49 inches)

Width 337.00 mm (13.27 inches)

Depth 258.34 mm (10.17 inches)

Weight with 8-cell battery and optical drive (starting at) 2.88 kg (6.35 lb)

**NOTE:** The weight of your laptop will vary depending on the configuration ordered and the manufacturing variability.

## Processor and System Chipset

---

Processor	Second Generation Intel Core i5 Second Generation Intel Core i7
L2 cache	256 KB
L3 cache	up to 8 MB
Bus clock	100 MHz
System chipset	Mobile Intel HM67 Express Chipset
SDRAM bus width	one or two 64-bit channels of DDR3 memory up to 1600 MHz
Processor address bus width	32 bits
Processor data width	64 bits
BIOS SPI Flash Memory	32 Mbit
Graphics bus	PCIe x16 bus Gen2

## CHAPTER 7: SPECIFICATIONS

### Memory

---

Connectors	two internally-accessible DDR3 using JEDEC SODIMM sockets
Capacities	1 GB, 2 GB, and 4 GB
Memory type	up to 1600 MHz unbuffered non-ECC dual-channel DDR3 configuration
Memory configurations possible	2 GB, 3 GB, 4 GB, 6 GB, and 8 GB

### Ports and Connectors

---

Network adapter	one RJ45 connector
USB	<ul style="list-style-type: none"><li>• one 4-pin USB 2.0-compliant connector with PowerShare</li><li>• two 4-pin USB 3.0-compliant connectors</li></ul>
HDMI	one 19-pin connector
Mini-DisplayPort	one 20-pin connector
VGA	one 15-hole connector



## Ports and Connectors

---

Audio	two stereo headphones/speaker connectors one microphone-in connector <b>NOTE:</b> You can also use the connectors to set up 5.1 channel speakers.
Media Card Reader	one 9-in-1 slot
SIM Card Reader	one SIM card slot

## Communications

---

Network adapter	10/100/1000 Mbps Ethernet LAN on system board
Wireless	<ul style="list-style-type: none"><li>• one half Mini-Card slot</li><li>• one full Mini-Card slot</li><li>• one full Display Mini-Card slot</li><li>• Bluetooth; Intel Wireless Display (optional); SiBeam WirelessHD (optional); 3G Wireless Internet (optional); 4G Wireless Internet (optional)</li></ul>

## CHAPTER 7: SPECIFICATIONS

### Video

---

#### Video controller

Integrated

Intel HD Graphics 3000

Discrete

NVIDIA GeForce GT555M

#### Video memory

Integrated

512 MB dedicated video memory (for total system memory greater than 4 GB)

Discrete

- 1.5 GB
- 3.0 GB

#### External display support

HDMI 1.4, Mini DisplayPort, VGA, Intel Wireless Display (optional), and SiBeam WirelessHD (optional)

### Audio

---

#### Type

High-Definition surround sound audio

5.1 analog connection and 7.1 HDMI connection

#### Controller

Realtek ALC665-GR

**Audio**

---

Speaker	dual 8-ohms speakers in both the left and right speaker assembly
Internal speaker amplifier	up to 2 W average per channel; up to 4 W average total power
Internal microphone support	1 subwoofer up to 3 W average
Volume controls	dual digital microphone-in camera assembly program menus and keyboard media function keys

**Hard-Drive Storage**

---

Number of storage drives	one
Hard drive	<ul style="list-style-type: none"><li>• one 2.5 inch SATA 2.0 (3Gb/s) hard drive</li><li>• one solid-state drive</li></ul>

### Media Card Reader

---

Cards supported

- Secure Digital (SD) memory card
- Secure Digital Input/Output (SDIO) card
- Secure Digital Extended Capacity (SDXC) card
- MultiMedia Card (MMC)
- MultiMedia Card plus (MMC+)
- Memory Stick
- Memory Stick PRO
- xD-Picture Card (type - M and type - H)
- Hi Density-SD (SDHD)
- Hi Capacity-SD (SDHC)

### Display

---

Type

- 14.0 inch HD WLED with TrueLife
- 14.0 inch HD+ WLED with TrueLife

Maximum internal resolution

1366 x 768 (HD)  
1600 x 900 (HD+)

## Display

---

### Dimensions (active area)

Height	173.95 mm (6.85 inches)
Width	309.40 mm (12.18 inches)
Diagonal	355.60 mm (14.00 inches)

Refresh rate 60 Hz

Operating angle 0° (closed) to 140°

Pixel pitch 0.1933 mm

Controls brightness can be controlled through keyboard shortcuts

## Keyboard (Backlit)

---

Number of keys 82 (Korea, U.S., and Canada); 83 (Europe); 86 (Japan)

Backlight color RGB; colors can be changed by invoking the AlienFX software in the Alienware Command Center. For information, see "Alienware Command Center" on page 40.

## CHAPTER 7: SPECIFICATIONS

### Touch Pad

---

X/Y position resolution (graphics table mode)	953 cpi
Size	
Height	42.0 mm (1.65 inches) sensor-active area
Width	81.0 mm (3.19 inches) rectangle

### Camera

---

Camera resolution	2.0 megapixel HD
Video resolution	1600 x 1200
Diagonal viewing angle	70°

### Battery

---

Type	8-cell "smart" lithium polymer (63 Whr)
Dimensions	
Height	11.2 mm (0.44 inches)
Width	173 mm (6.81 inches)
Depth	109.4 mm (4.31 inches)

**Battery**

---

Weight	0.43 kg (0.94 lb)
Voltage	14.8 V
Operating time	battery operating time varies depending on operating conditions and can be significantly reduced under certain power-intensive conditions.
Life span (approximate)	300 discharge/charge cycles
Temperature range	
Operating	0° to 50°C (32° to 122°F)
Storage	-20° to 60°C (-4° to 140°F)
Coin-cell battery	CR-2032

### AC Adapter

---

Type	150 W
Input voltage	100 - 240 VAC
Input current (maximum)	2.50 A
Input frequency	50-60 Hz
Output current	7.70 A (continuous)
Output power	150 W
Rated output voltage	19.50 V
Temperature range	
Operating	0° to 35°C (32° to 95°F)
Storage	-40° to 70°C (-40° to 158°F)
Connector types	
DC connector	3-pin, 7.4 mm plug
AC connector	3-pin – C13



## Computer Environment

---

### Temperature range

Operating 0° to 35°C (32° to 95°F)

Storage -40° to 65°C (-40° to 149°F)

### Relative humidity (maximum)

Operating 10% to 90% (non-condensing)

Storage 10% to 95% (non-condensing)

### Maximum vibration (Using a random vibration spectrum that simulates user environment)

Operating 0.66 GRMS

Storage 1.3 GRMS

### Computer Environment

---

Maximum shock (Measured with hard drive in operating status and a 2-ms half-sine pulse for operating. Also measured with hard drive in head-parked position and a 2-ms half-sine pulse for storage)

Operating 110 G

Storage 160 G

Altitude (maximum)

Operating -15.2 to 3048 m (-50 to 10,000 ft)

Storage -15.2 to 10,668 m (-50 to 35,000 ft)

Airborne contaminant level G2 or lower as defined by ISA-S71.04-1985



# APPENDIX



# GENERAL AND ELECTRICAL SAFETY PRECAUTIONS

## Computer Setup

- Read all instructions marked on the product and in the documentation before operating your computer.
- Retain all safety and operating instructions.
- Never use this product near water or a heat source.
- Only set-up the computer on a stable work surface.
- Only operate the computer using the power source type indicated on the rating label.
- Never block or cover any openings or fans in the computer case. These are required for ventilation.
- Never insert objects of any kind into the ventilation openings.
- Ensure that your computer is properly grounded when in use.
- Do not attempt to connect your computer into an outlet that is not properly grounded.
- If an extension cord is used with your computer, ensure that the total ampere rating on the computer does not exceed the maximum rating on the extension cord.

## Computer Use

- Route the power cable and all cables away from where people might walk or trip over them. Do not allow anything to rest on the power cable.
- Do not spill anything on or into your computer.
- To avoid electrical shock, always disconnect all power, modem and any other cables from the wall outlets before handling the computer.

## Electrostatic Discharge (ESD) Warning

Electrostatic Discharge (ESD) can cause damage to internal system components if precautions are not taken. ESD is caused by static electricity and the damage caused is usually permanent.

Computer technicians wear a special wrist-strap that grounds them to the computer's case to prevent ESD damage. To reduce the chances of ESD damage:

- Turn off your computer's power and wait several minutes before starting to work.
- Ground yourself by touching the case of the computer.
- Avoid walking around while replacing items inside the case, especially if you are on a carpet or during low temperature and low humidity.
- Touch only those items which must be replaced.
- If you have to remove peripheral cards for any reason, place them on the portion of the computer's case that was removed. Do not touch the edge connectors at the bottom of the card that connect to the system board.

### General Safety Precautions

- **Mechanical Shock:** Your computer should never be subjected to severe mechanical shocks. Careless handling of your computer may cause damage. Mechanical shock is not covered by the warranty.
- **Electrical Shock:** If you do not open up your computer, there is nothing to worry about. Your computer protects itself against most irregularities in the power source.

### When You Should Contact Alienware

- The battery, power cable or connector is damaged.
- Your computer has had liquid spilled into it.
- Your computer was dropped or the case was damaged.
- Normal operation of the computer does not occur when the operating instructions are followed.

### Replacement Components or Accessories

It is only advised to use replacement parts or accessories recommended by Alienware.

## Contacting Alienware

For customers in the United States/Canada, call 1-800-ALIENWARE.

 **NOTE:** If you do not have an active Internet connection, you can find contact information on your purchase invoice, packing slip, bill, or Dell product catalog.

Dell provides several online and telephone-based support and service options. Because availability varies by country and product, some services may not be available in your area.

To contact Dell for sales, technical support, or customer service issues:

1. Visit **dell.com/contactdell**.
2. Select your country or region.
3. Select the appropriate service or support link based on your need.
4. Choose the method of contacting Dell that is convenient for you.

# Websites

You can learn about Alienware products and services on the following websites:

- **dell.com**
- **dell.com/ap** (Asian/Pacific countries only)
- **dell.com/jp** (Japan only)
- **euro.dell.com** (Europe only)
- **dell.com/la** (Latin American and Caribbean countries)
- **dell.ca** (Canada only)

You can access Alienware Support through the following websites:

- **support.dell.com**
- **support.jp.dell.com** (Japan only)
- **support.euro.dell.com** (Europe only)
- **support.la.dell.com** (Argentina, Brazil, Chile, Mexico)



## Information for NOM, or Official Mexican Standard (Only for Mexico)

The following information is provided in the device(s) described in this document in accordance with the requirements of the Official Mexican Standard (NOM):

Importer:

Dell México S.A. de C.V.  
Paseo de la Reforma 2620 - Flat 11°  
Col. Lomas Altas  
11950 México, D.F.

<b>Regulatory Model Number</b>	<b>Voltage</b>	<b>Frequency</b>	<b>Electricity Consumption</b>	<b>Output Voltage</b>	<b>Output Intensity</b>
P18G	100-240 VAC	50-60 Hz	2.50 A	19.50 V	7.70 A

For details, read the safety information that shipped with your computer.

For additional safety best practices information, see [dell.com/regulatory\\_compliance](https://www.dell.com/regulatory_compliance).

